

Proportional Wegeschieberventil PSL / Proportional directional spool valve PSL

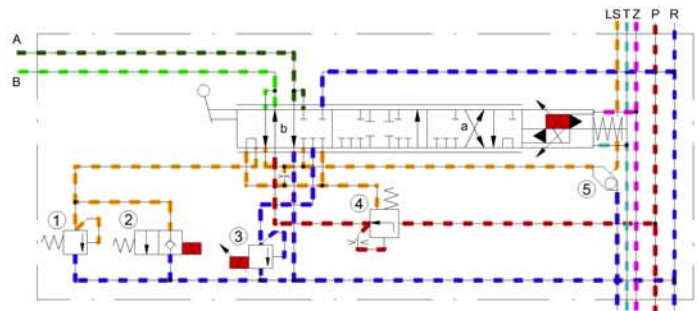

Axialkolbenverstellpumpe V60N / Axial piston variable displacement pump V60N

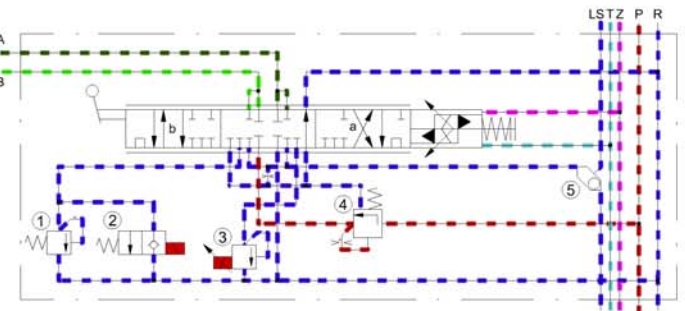
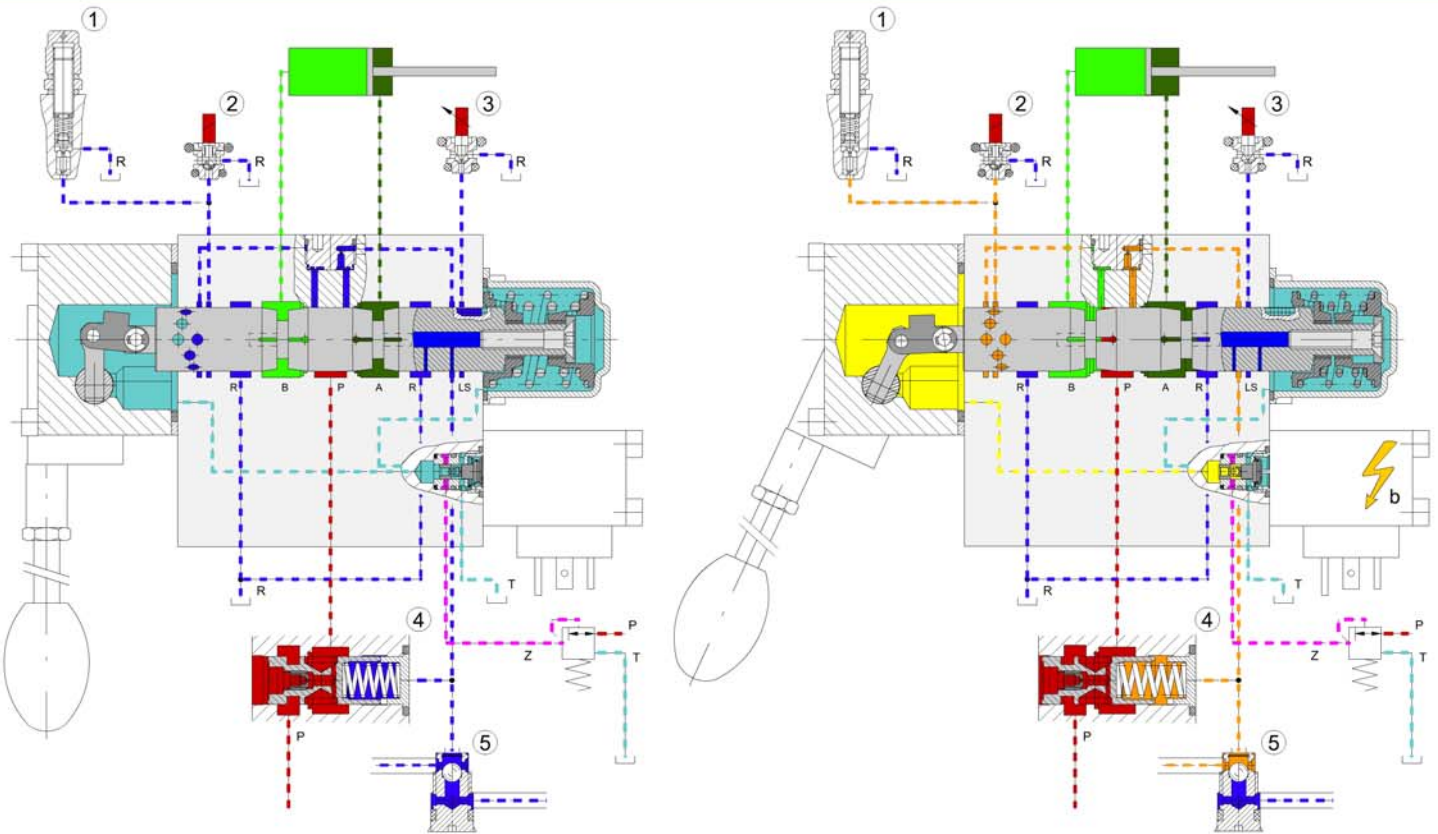
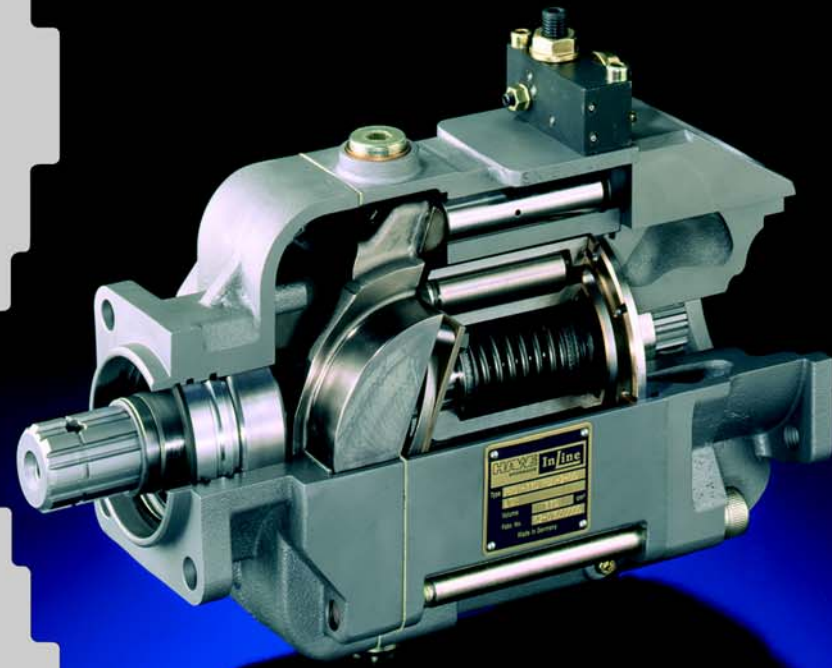
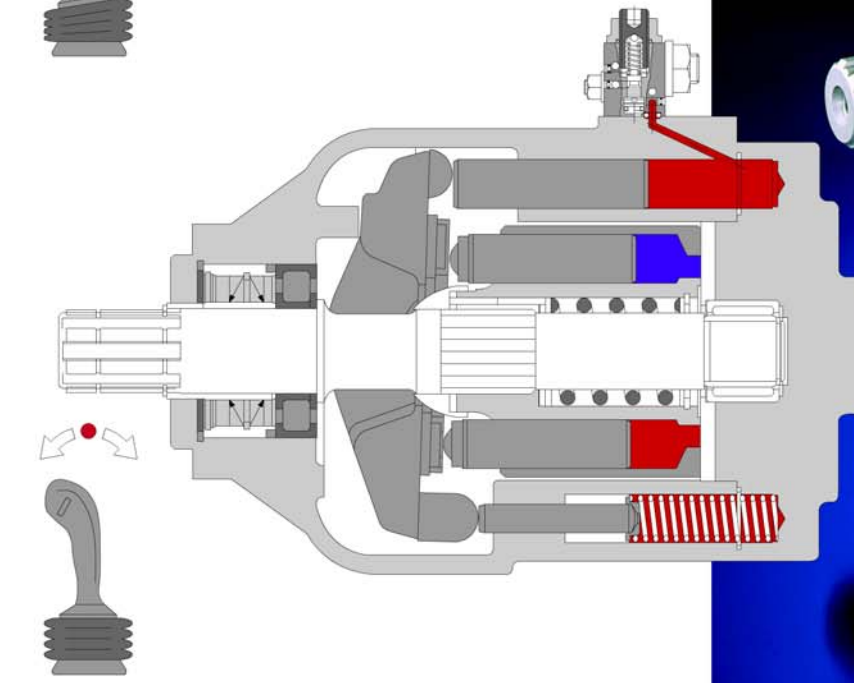
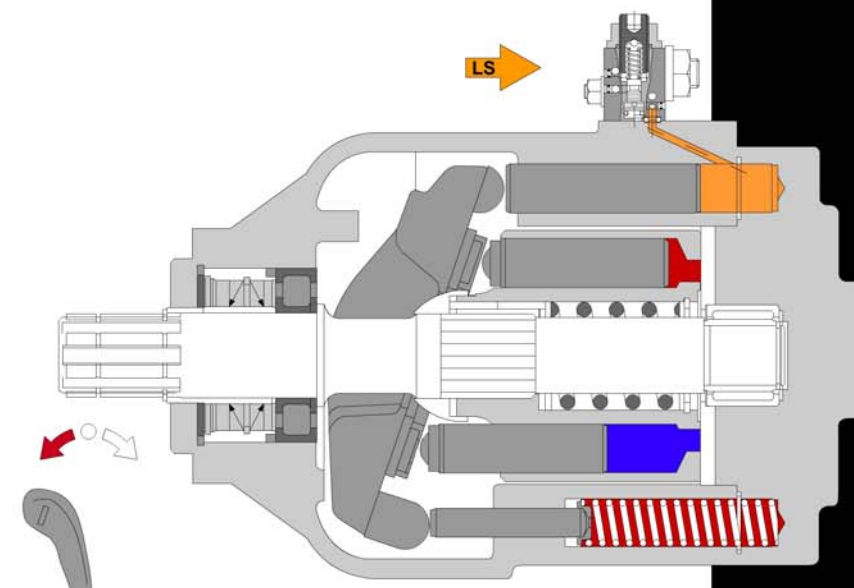
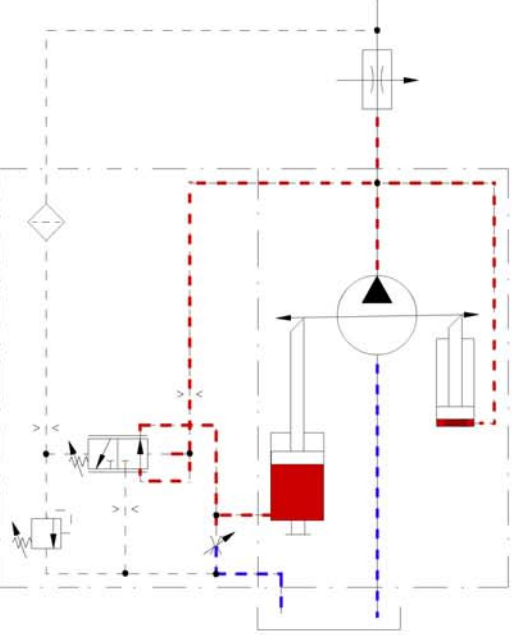
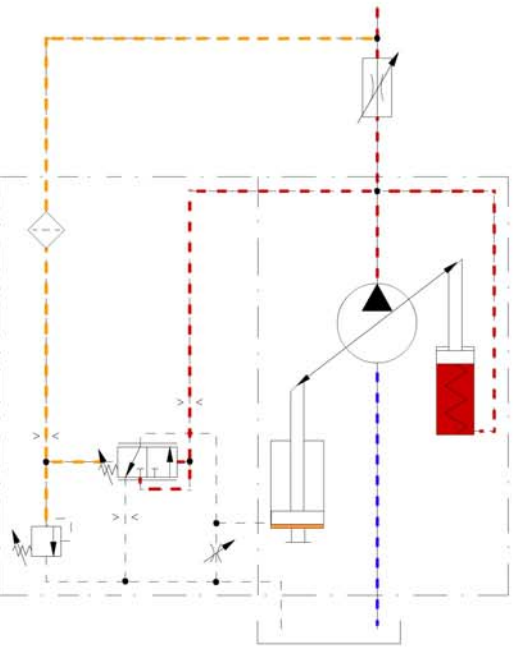

Lasthalteventil LHK / Over-center valve LHK

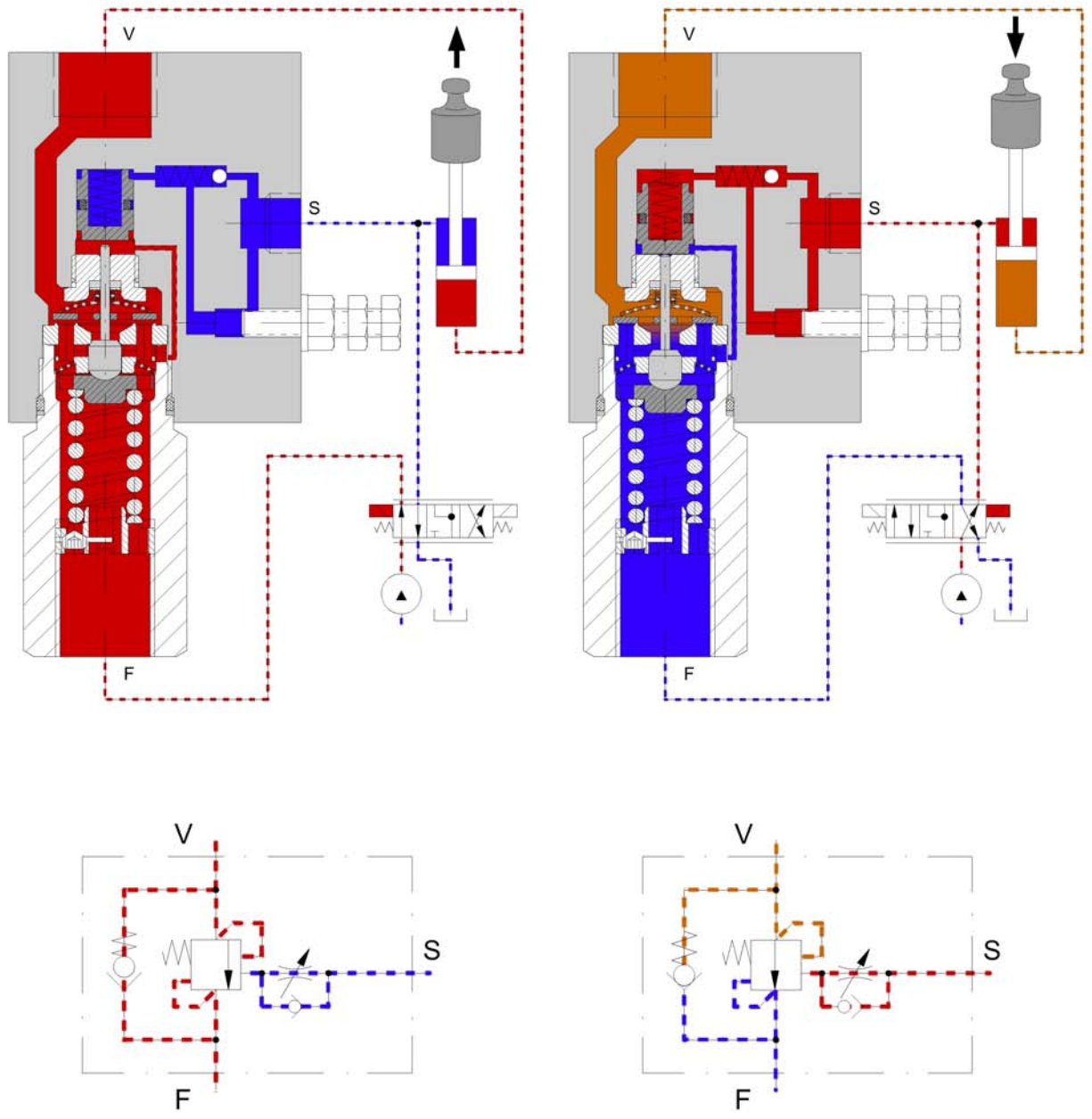

ИНТЕРПРОМТЕХНИКА · Красногвардейский пер., д. 15, лит. А · Санкт-Петербург
Телефон/факс +7 (812) 320-04-56 · www.interpromtechnika.ru · info@interpromtechnika.ru

Solutions for a World under Pressure

HAWES
HYDRAULIK